

HOUSE OF
DURATECH
innovative pool products

Manual

SUN05
SUN08
SUN12



HEAT Sun Spring

Table of contents

Box contents.....	3
Dimensions.....	3
1. Specifications.....	4
1.1 Performance data Sun Spring.....	4
2. Preface.....	6
3. Safety information.....	6
4. Preparing the heat pump for use.....	7
4.1 Typical set-up.....	7
4.2 Water connection kit.....	8
4.3 Installation of the tubing.....	9
4.4 Electrical wiring.....	9
5. Be aware of.....	10
5.1 Heat loss.....	10
5.2 Condensation.....	10
5.3 Unobstructed space.....	10
5.4 Time delay of compressor.....	11
6. Operation and use.....	11
6.1 Before operation.....	11
6.2 Initial startup.....	11
6.3 General interface.....	12
6.4 Parameter interface.....	13
6.5 Parameter list.....	14
6.6 Error interface.....	15
6.7 Error parameter interface.....	15
6.8 Error list.....	16
6.9 Trouble shooting guide.....	17
7. Wiring diagrams.....	18
7.1 Wire control interface diagram Sun Spring.....	18
7.3 Piping diagram and definition Sun Spring.....	19
8. Maintenance and inspection.....	20
8.1 Water chemistry.....	20
9. Winterizing.....	21
9.1 Spring startup.....	21
10. Environment.....	21
11. Service.....	21
12. Warranty.....	22

DURAHEAT

Box content

Connection kit

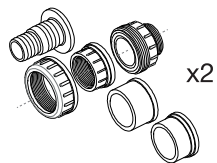

Manual



Heat pump Sun Spring

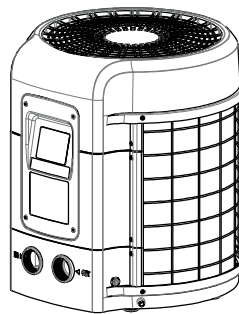

Dimensions

SUN05 / SUN08

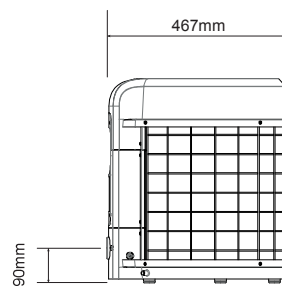
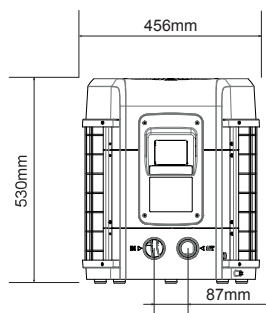

SUN12

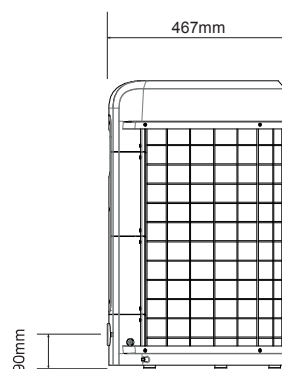
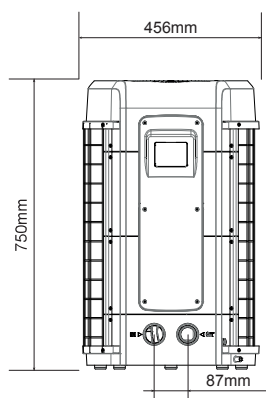

1. Specifications

1.1 Performance data Sun Spring

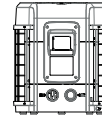
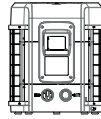

UNIT		SUN05	SUN08
Advised Pool volume*	m ³	12	25
Operating air temperature	°C	4 ~ 40	
<i>Air 27°C / Water 26°C / Humidity 80%</i>			
Heating Capacity	kW	5,02	7,44
	Btu	17129	25386
Consumed power	kW	0,686	1,01
COP		7,31	7,31
<i>Air 15°C / Water 26°C / Humidity 70%</i>			
Heating Capacity	kW	3,64	5,3
	Btu	12420	18084
Consumed power	kW	0,639	0,978
COP		5,69	5,36
Power supply		230V / 50Hz / 1 Phase	
Electronic Controller		Colour LCD	
Nominal Running current	A	3,1	5,1
Max Current	A	5	7
RCD - Rated current	A	10 EU/UK/SWISS	10 EU/UK/SWISS
RCD - Leakage current	mA	30	
Condensor		Titanium Heat Exchanger / NoFrost	
Compressor quantity		1	1
Compressor type		Rotary	Rotary
Refrigerant		R32	
Refrigerant weight	kg	0,45	0,74
Fan quantity		1	1
Fan power input	W	70	80
Fan rotary speed	RPM	950	1200
Fan direction		Vertical	
Noise at 10m	dB(A)	44,2	43,8
Water connection	mm	38	38
Water flow range	m ³ /h	3 - 12	4 - 12
Unit net dimensions (L*W*H)	mm	See dimensions on p3	
Unit shipping dimensions (L*W*H)	mm	470x490x550	
Net weight	kg	24,7	32
Shipping weight	kg	25,7	33

* Advised pool volume for an entirely insulated pool, with cover, free from wind and exposed to the sun.

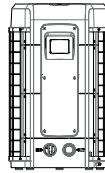

UNIT		SUN12
Advised Pool volume*	m ³	38
Operating air temperature	°C	4 ~ 40
<i>Air 27°C / Water 26°C / Humidity 80%</i>		
Heating Capacity	kW	12,2
	Btu	41628
Consumed power	kW	2,068
COP		5,9
<i>Air 15°C / Water 26°C / Humidity 70%</i>		
Heating Capacity	kW	9
	Btu	30709
Consumed power	kW	1,837
COP		4,9
Power supply		230V / 50Hz / 1 Phase
Electronic Controller		Colour LCD
Nominal Running current	A	9
Max Current	A	12
RCD - Rated current	A	16 EU/SWISS & 13 UK
RCD - Leakage current	mA	30
Condensor		Titanium Heat Exchanger / NoFrost
Compressor quantity		1
Compressor type		Rotary
Refrigerant		R32
Refrigerant weight	kg	0,95
Fan quantity		1
Fan power input	W	80
Fan rotary speed	RPM	1200
Fan direction		Vertical
Noise at 10m	dB(A)	44,7
Water connection	mm	38
Water flow range	m ³ /h	5 - 12
Unit net dimensions (L*W*H)	mm	See dimensions on p3
Unit shipping dimensions (L*W*H)	mm	470x490x770
Net weight	kg	45,7
Shipping weight	kg	46,7

* Advised pool volume for an entirely insulated pool, with cover, free from wind and exposed to the sun.

2. Preface

In order to provide our customers with a high quality and reliability, this product has been made to strict production standards. This manual includes all the necessary information about installation, debugging, discharging and maintenance. Please read this manual carefully before you open or maintain the unit. The manufacturer of this product can not be held responsible if someone is injured or the unit is damaged, as a result of improper installation or maintenance. It is vital that the instructions within this manual are adhered to at all times. The unit must be installed by a qualified person.

The heat pump will **always** perform very well, provided the following elements are present

1. Fresh air



2. Electricity



3. Swimming pool water



3. Safety information

Please read these instructions carefully before using the heat pump and keep them for future reference:





1. Always keep the unit upright. If the unit has been tilted or put on its side, wait 24h before starting the heat pump.
2. Put the unit on a flat, solid base. Tilting the heat pump for max 3° is accepted.
3. Do not drop the heat pump.
4. The heat pump must always be installed outdoors.
5. Check if the voltage indicated on the heat pump corresponds to the local mains voltage before you connect the unit. Please find more information about the electrical connection in section 4.4
6. Do not pull any electrical cable, sensor or tubing with unnecessary force.
7. Do not wrap any cable around the heat pump.
8. Do not use the heat pump in combination with a transformer.
9. If the heat pump is damaged during transportation, it must be replaced, please contact your service centre or similarly qualified persons in order to avoid a hazard.
10. Always make sure the water connections of the heat pump are properly locked before you start using the machine.
11. Never insert objects directly into the fan, as this will cause it to become blocked and damaged.
12. The evaporator fins must not be damaged.
13. This heat pump is not intended for use by persons with reduced physical, sensory or mental capabilities, or lack of experience and knowledge, unless they have been given supervision or instruction concerning use of the heat pump by a person responsible for their safety.
14. Children should always be supervised to ensure that they do not play with the heat pump.
15. Disconnect electricity when the heat pump is not in use and before cleaning.
16. The heat pump should be serviced only by a qualified service person. Contact your nearest authorized service facility for examination, repair or adjustment.
17. If the supply cord is damaged, it must be replaced by the manufacturer or your service agent or similarly qualified person in order to avoid a hazard.
18. Please contact your dealer if your swimming pool heat pump is not working properly. There might be a leakage when the heat pump does not heat the swimming pool water. The R32 refrigerant gas is safe when there is a leakage although fire can occur when a flame, heating device or stove gets in contact with the gas. Stop using your swimming pool heat pump until a qualified service technician has confirmed that the leak has been repaired.
19. Make sure that there is a circuit breaker for the unit, lack of a circuit breaker can lead to electrical shock or fire.
20. The heat pump is equipped with an over-load protection system. It does not allow for the unit to start for at least 3 minutes from a previous stoppage.
21. The condens water is not suitable for a potable water connection.

4. Preparing the heat pump for use

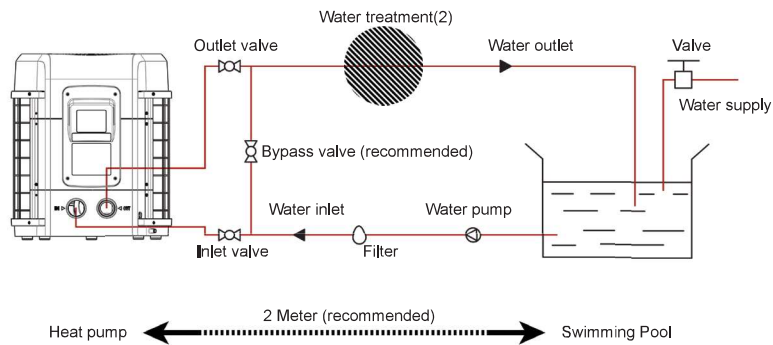
4.1 Typical set-up

The factory provides the heat pump and connection kit. Other parts, including a contingent by-pass must be provided by the user or installer. The heat pump should be located 2m (recommended) away from the swimming pool. The longer the distance from the pool, the greater the heat loss from the piping.



-  Put the heat pump on a flat, solid base. Tilting the heat pump for max 3° is allowed. Install silent blocks in order to avoid vibrations and noise.
-  All feeding of water treatment to the pool water has to be done downstream of the heat pump(2).
-  It is normal for condens water to come out of the heat pump. This is not a leak or fault with the unit. If the humidity is very high, the condens water could be a number of liters a day. Please find more information about condensation in section 5.2.
-  Always keep the heat pump in upright position. If the unit has been tilted, then wait 24h before starting the heat pump.
-  It is recommended to install a by-pass for easy maintenance.

4.2 Water connection kit

The factory provides the water connecting kit. This kit consists of 6 parts, with part 1 and 2 as main parts. The parts 3 to 6 can be swapped so that the connection can be made according to the specific requirements of the pool. So in total there are 4 possible options for connecting the water pipes, as shown below.

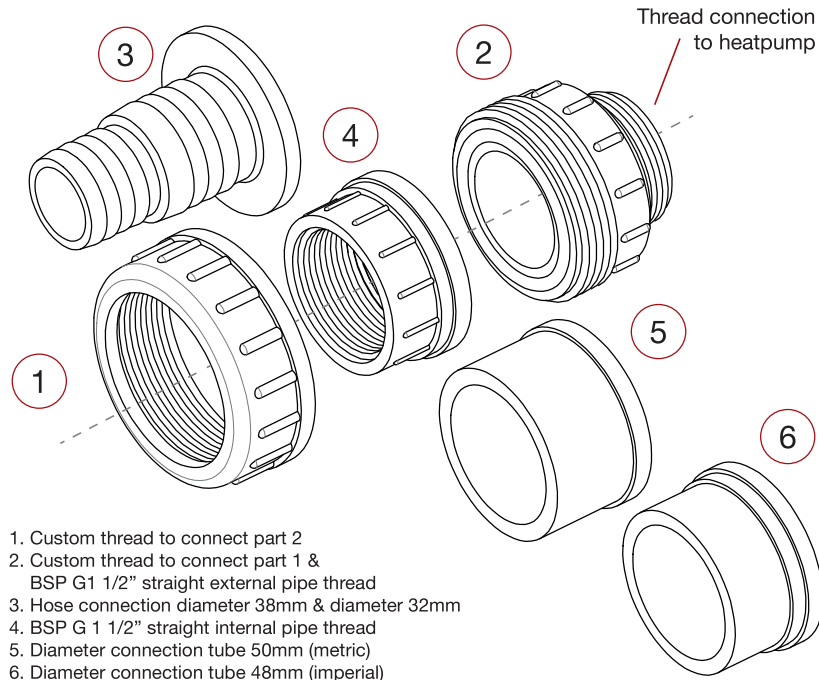

Clamping connection

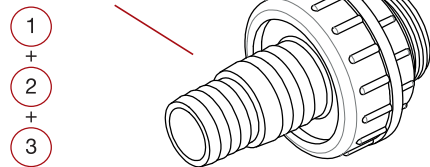

Thread connection

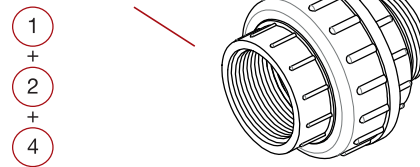

Glue connection

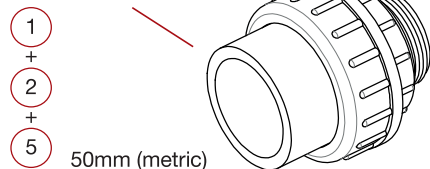

Glue connection

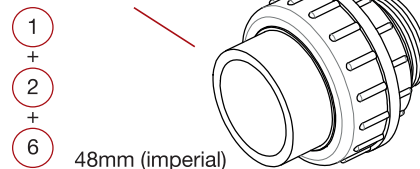

4.3 Installation of the tubing

The heat pump should be located 2m (recommended) away from the swimming pool. The longer the distance from the pool, the greater the heat loss from the piping. The piping to and from the heat pump need to fit the chosen connections. The pipes can be glued, clamed or screwed onto these water connections and can be made out off hard or flexible PVC. Always install piping intended for swimming pool use and use the correct glue to put them together.

OUT - Water connection from heat pump:

Typical water pipe from heat pump to water treatment system.

IN - Water connection to heat pump:

Typical water pipe from filter system to heat pump.

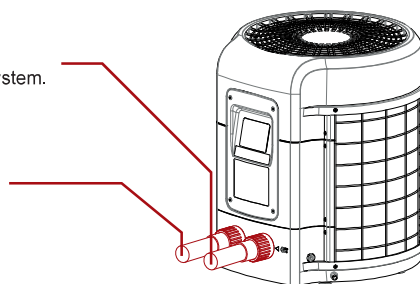

4.4 Electrical wiring

Always check if the voltage from the network corresponds with the operating voltage of the unit. Your typical swimming pool configuration can be controlled using a timer. Please contact your service centre or similarly qualified persons to change the RCD into a standard electrical plug. A timer can be put in between the heat pump AND pool circulation pump once a standard electrical plug is installed. Using a timer; The heat pump and pool circulation pump will start up automatically as soon as power is broken and restored. The heat pump remembers its last status and starts up with last remembered settings.

 Although the heat pump is electrically isolated from the rest of the pool equipment, this only prevents the passage of electricity to or from the pool water. Grounding the unit is still required to protect yourself from short circuits inside the unit. Provide an adequate ground connection.

 Test the RCD before usage as follows:

1. Plug the RCD into a fixed socket
2. Press the "RESET" button. The indicator should be "ON".
3. Press the "TEST" button. The indicator should be "OFF".
4. Press the "RESET" button again to start using the heat pump



You should always switch off the heat pump immediately when the RCD indicator is turned "OFF". Be extremely careful when pressing "RESET" after a failure because there might still be a problem.

The controller of the Sun Spring heat pump has a memory so that the settings are retained even if the power is switched off and on. This makes it possible to operate the heat pump with a timer. The timer must be installed between the heat pump and the RCD plug, see picture. The installation must be carried out by a certified electrical installer in order to guarantee quality and safe operation.

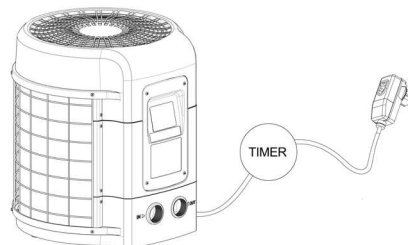

5. Be aware of

5.1 Heat loss

The longer the distance from the pool, the greater the heat loss from the tubing. It is therefore recommended to place the pump as close to the pool as possible.



Several days will be needed to bring the temperature of the swimming pool water to its desired water temperature, depending on the initial water temperature, ambient and pool volume.



A good pool cover and insulation of the tubing to and from the swimming pool and heat pump can reduce the warming up time considerably.

5.2 Condensation

As the heat pump cools down the air about 10°C, water may condense on the fins of the evaporator. If the relative humidity is very high, this could be as much as several liters an hour. The water will run down the fins into the base pan and drain out through the hole at the bottom of the heat pump. Sometimes this condensation water is wrongly considered as swimming pool water. If desired the heatpump can be fitted with a clear vinyl tube, to divert the condensation water away from the heatpump.

TIP:

A quick way to verify that the water is condensation is to shut off the unit and keep the pool pump running. If the water stops running out of the base pan, it is condensation. AN EVEN QUICKER WAY IS TO TEST THE DRAIN WATER FOR CHLORINE - if there is no chlorine present, then it's condensation.



Check regularly that the drainage is not clogged and that no condensation water remains in the heatpump.

5.3 Unobstructed space

A free area around the heat pump has to be kept clear from any object to get fresh air across the evaporator. Do not obstruct the fan.

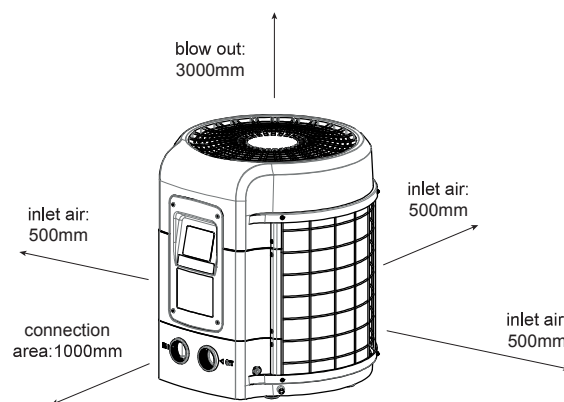

5.4 Time delay of compressor

The heat pump is equipped with a 3 minute built-in solid state restart delay once the compressor is turned off and a 1 minute built-in solid state compressor running time. Both to protect control circuit components, to eliminate restart cycling and contactor chatter. This time delay will automatically restart the unit approximately 3 minutes after each control circuit interruption or after a compressor running period of 1 minute. Even a brief power interruption will activate the solid state 3 minute restart delay and prevent the unit from starting until the 3 minute countdown is completed. Alarms or errors during time delay have no influence. Power interruptions during the delay period will cause a restart of time delay.

6. Operation and Use

6.1 Before operation

The desired temperature can directly be set with the arrow keys. The setting will automatically be stored in memory. A choice can be made between °C and °F as follows:

1. Enter the parameter menu by pushing the up and down button simultaneously.
2. Go to the fahrenheit parameter (P02) by pressing up/down buttons.
3. Press the on/off button to enter the parameter set mode.
4. Adjust the parameter to the desired value. When the parameter is set to 1, all temperatures should be in °F instead of °C.
5. Press the on/off button to leave the parameter set mode.
6. Exit the parameter menu by pushing the up and down button simultaneously.

6.2 Initial startup

The following steps need to be taken at startup (after verification that all the connections are made to the according specifications):

1. Turn on the filter pump. Check for possible water leakage and water flow to and from the swimming pool.
2. Put the power plug into the outlet and switch the heat pump ON. The unit will start after the time delay (see 5.4).
3. Verify after a few minutes that the air exhausted by the heat pump is becoming cooler.
4. Allow the unit and pool pump to run 24 hours per day until desired pool water temperature +0,5°C is reached. When the set temperature is reached, the unit shuts off. The unit will automatically restart when the pool temperature drops 0,5°C below set temperature.

6.3 General interface

The heat pump can be turned on or off with the ON/OFF button.

1. When OFF the display is showing the following information:

- The indication 'OFF' at the location of the pool water temperature
- The temperature wanted for heating
- Eventual error messages

2. When ON the display is showing the following information:

- The temperature wanted for heating
- The pool water temperature
- The indication 'Heating' when the unit is heating the water
- A graphical representation of the water flow: the flow bar

The heat pumps has it best performance when the flow bar is in the green zone. The graph is only valid after at least 15 minutes of operation, as the operation of the pump takes some time to reach its optimum working balance.

 The flow bar is a graphical representation of the water volume through the unit.

Low air temperature:

The heat pump stops working at 3,5°C and will restart automatically when the ambient temperature is above 4°C.

Set temperature:

Shows the desired temperature of the swimming pool. Your heat pump will stop heating when desired temperature is reached. The heat pump will start automatically when the water temperature drops below set point.

Pool temperature:

Shows the temperature of the swimming pool.

High air temperature:

The heat pump will stop working when the ambient temperature is above 40,5°C. and will restart automatically when the ambient temperature is below 40°C.

Low flow:

The heat pumps stops working. The amount of water flow going through the heat pump is too low. The heat pump will restart automatically when the water flow is restored.

Flow bar:

Indicates the amount of water flow going through the heat pump.

ON/OFF:

Press the ON/OFF button to start the heat pump. The current water temperature will appear and the heat pump will start automacitally. The heat pump won't start when the desired water temperature is reached. Meanwhile the current water temperature is shown on the display.

Press the ON/OFF button to stop the heat pump. OFF will appear on the display.

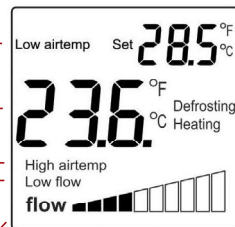

UP:
Press to increase desired temperature. Any changes will be saved automatically.

Down:
Press to reduce desired temperature. Any changes will be saved automatically.

Defrosting:
Highlights when the heat pump is defrosting.

Heating:
Highlights when the heat pump is heating.

6.4 Parameter interface

By pressing UP & DOWN simultaneously the parameter interface we'll be entered. Here all the parameters are shown and can be set by a qualified person in order to make the heat pump more efficient, depending on the specific conditions of the swimming pool. A complete list of parameters can be found in the parameters list, section 6.5.

Parameter name:

Name of parameter. The following can be found:

- P01 to P11 Factory editable settings/parameter
- EA Sensor settings/parameter
- EE
- En
- EL

Set:
Is not visible when you scroll through the list of parameters. When the ON/OFF has been pushed it will be visible and the selected parameter can be changed.

Value parameter:
Current value of the selected parameter. Any changes will be saved automatically.

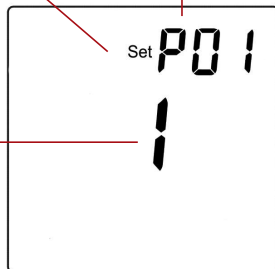

Up:
Scroll up through the list of parameters.
Edit the value of the selected parameter.



Down:
Scroll down through the list of parameters.
Edit the value of the selected parameter.



ON/OFF:
Select the parameter you want to edit

6.5 Parameter list

Parameter	Name	Min.	Max.	Factory	Description	PSWD
P1	SW_VERSION	/	/	/	Software version	/
P2	FAHRENHEIT	0	1	0	0 is °C, 1 is °F	/
P3	PSWD_1	0,0	999,0	0,0	Password 1	/
P4	PSWD_2	0,0	999,0	0,0	Password 2	/
P5	/	/	/	40,0	/	PPS PASSWORD
P6	/	/	/	4,0	/	PPS PASSWORD
P7	/	/	/	2,5	/	PPS PASSWORD
P8	/	/	/	10,0	/	PPS PASSWORD
P9	/	/	/	0,5	/	PPS PASSWORD
P10	/	/	/	10,0	/	PPS PASSWORD
P11	/	/	/	5,0	/	PPS PASSWORD
TA	Ambient temperature	/	/	/	Value of the ambient temperature.	/
TIN	Water in temperature	/	/	/	Value of the water inlet temperature.	/
TE	Evaporator temperature	/	/	/	Value of the evaporator temperature.	/
TLI	Liquid line temperature	/	/	/	Value of the gas temperature after the heat exchanger	/



SET on the display highlights in the parameter menu when the parameters can be changed.

6.6 Error interface

When an issue is detected the heat pump will try to solve it by analyzing several parameters, restarting components and bypassing electronics. An error is shown on the display when the program can not solve the issue.

The heatpump will stop working and can only be restarted by unplugging the RCD. If the pump still shows the error after that, please contact your service centre or similarly qualified person.

Count of errors in the heat pump:

Number of errors. The following can be found:

EO1 to EO4

Err:
Notification of error.

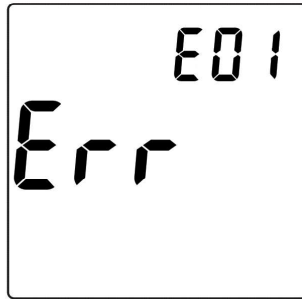

UP & DOWN:
Press to enter error parameter interface and see which errors occur.

6.7 Error parameter interface

By pressing UP & DOWN simultaneously the Error parameter interface we'll be entered. Here it is shown which specific errors have occurred. A complete list of errors can be found in the error list, section 6.8.

Number of the error in the heat pump:

Number of the error. The following can be found:

EO1 to EO4

Error notification name:
Name of error in the heat pump. The following can be found:

EA Ambient temperature sensor error

EE Evaporator temperature sensor error

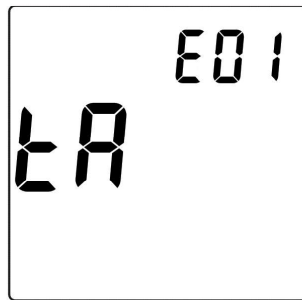

EW Water inlet temperature sensor error

EL Liquid line temperature sensor error

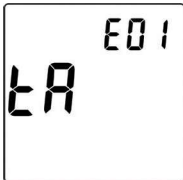
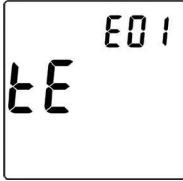
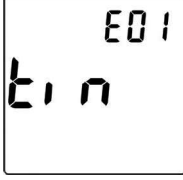

UP & DOWN:
Press to toggle between errors.

6.8 Error list

Error name	Error paramater interface	Description	Effect / action
Ambient temperature error		-The ambient temperature sensor is broken or disconnected. - E01 Total number of errors in the system(Min E01 max E04).	The heatpump will stop working and can only be restarted by unplugging the RCD. If the pump still shows the error after that, please contact your service centre or similarly qualified person.
Evaporator temperature error		- The evaporator temperature sensor is broken or disconnected. - E01 Total number of errors in the system(Min E01 max E04).	The heatpump will stop working and can only be restarted by unplugging the RCD. If the pump still shows the error after that, please contact your service centre or similarly qualified person.
Condensor water inlet temperature error		-The water inlet temperature sensor is broken or disconnected. - E01 Total number of errors in the system(Min E01 max E04).	The heatpump will stop working and can only be restarted by unplugging the RCD. If the pump still shows the error after that, please contact your service centre or similarly qualified person.
Liquid line temperature error		-The liquid line temperature sensor is broken or disconnected. - E01 Total number of errors in the system(Min E01 max E04).	The heatpump will stop working and can only be restarted by unplugging the RCD. If the pump still shows the error after that, please contact your service centre or similarly qualified person.

6.9 Trouble shooting guide

Improper installation will create an electrical hazard, which could result in death or serious injury to pool users, installers, or others due to electrical shock, and may also cause damage to property.

Problem	Cause	Solution
Heat pump not running	1. No electricity	1. Switch on the electrical power
	2. Unit not turned on	2. Switch on the heat pump
	3. Wrong temperature setting	3. Adjust the temperature setting
	4. Time delay still activated	4. Wait 3 min for unit to start
	5. Air temperature below 4°C	5. Wait until temperature has risen
	6. Other	6. See 'error messages'
Insufficient heating	1. Obstacles blocking air flow	1. Remove obstacles
	2. Ice on the evaporator	2. Pump will try to defrost itself

- DO NOT attempt to make any adjustments inside the heater.
- Keep your hands and hair clear of the fan blades to avoid injury.
- If you are not familiar with the pool filtering system and heater:
 - Do not attempt to adjust or service without consulting your dealer, professional pool or air conditioning contractor.
 - Read the entire installation and users guide before attempting to use, service or adjust the heater or pool filtering system
 - Do not start the heat pump until 24 hours after installation to avoid damaging the compressor.
- Turn off power to the unit prior to attempt service or repair.

7. Wiring diagrams

7.1 Wire control interface diagram Sun Spring

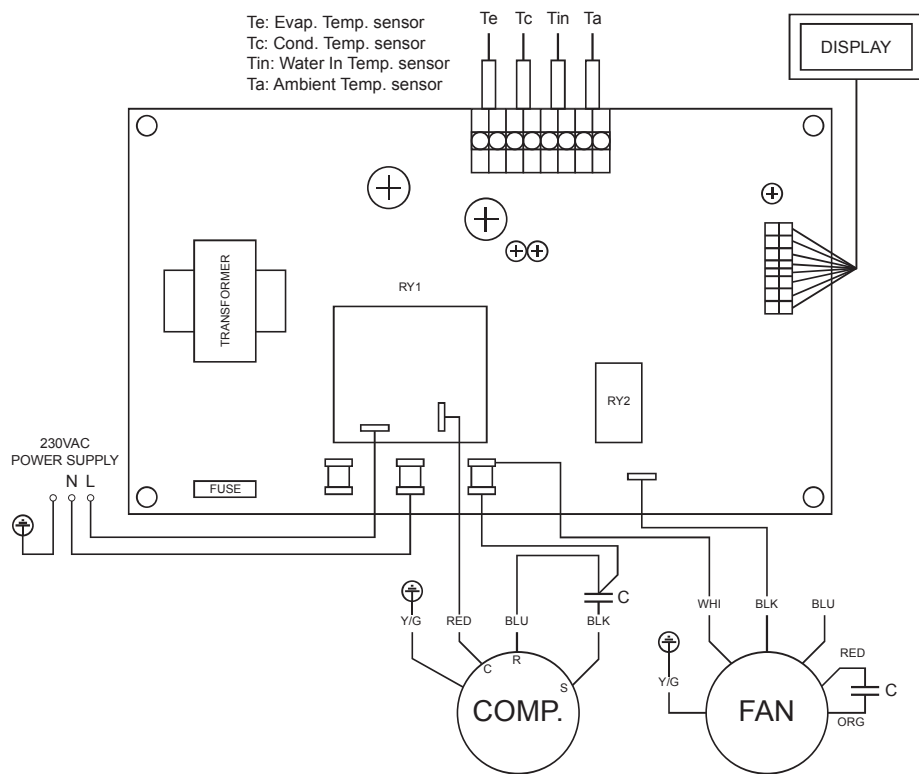

7.2 Piping diagram and definition Sun Spring

ENG

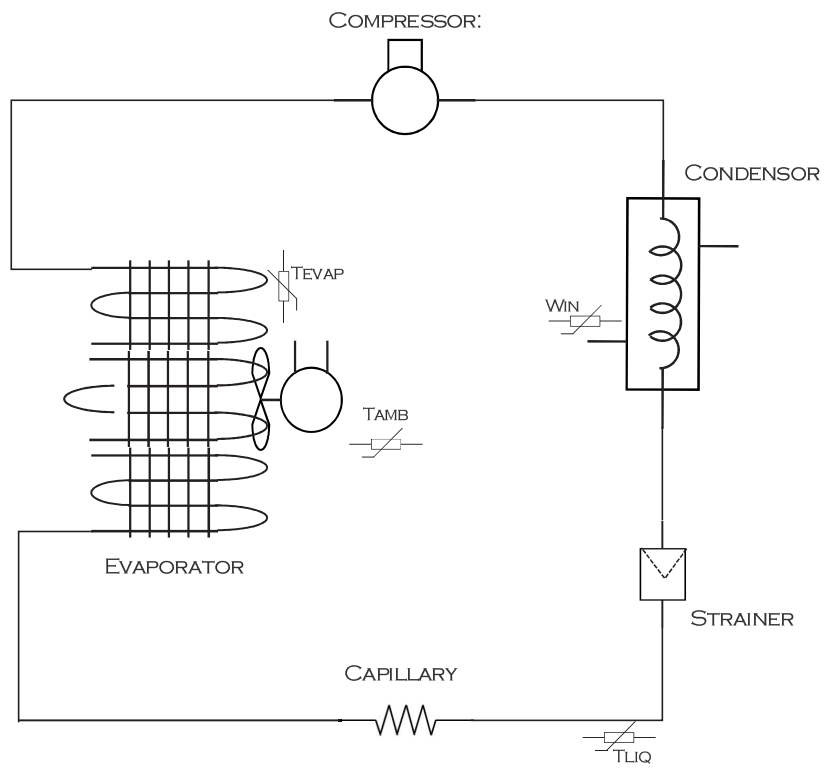

8. Maintenance and Inspection

- Check the water inlet and drainage often. The water and air inflow into the system should be sufficient so that its performance and reliability does not get compromised. You should clean the pool filter regularly to avoid damage to the unit caused by clogging of the filter.
- The area around the unit should be spacious and well ventilated as shown in section 5.3. Clean the sides of the heat pump regularly to maintain good heat exchange and to save energy.
- Check if all processes in the unit are operational.
- Check the power supply and cable connections regularly. Should the unit begin to function abnormally or should you notice a smell from an electrical component, arrange for timely repair or replacement.
- You should also purge the water if the unit will not work for an extended period of time. You should check all parts of the unit thoroughly and completely fill the system with water before turning it on again afterwards.

If your heat pump has been stored for a long time, perform the following steps when re-starting the system:

1. Inspect the system for any debris or damage to the case.
2. Clean the evaporator fins with a soft cloth if necessary. Make sure the evaporator fins are clean. Blocking the air intake will cause insufficient operation and will result in lower production of heat.
3. Check the fan for blockages.
4. Connect the water inlet and outlet.
5. Turn on the pool water circulation pump to start the water flow to the heat pump.
6. Restore electrical power to the heat pump and press the reset button on the RCD.

8.1 Water chemistry

Special care should be taken to keep the chemical balance of your swimming pool within following limits:

	Min.	Max.
pH	7,0	7,8
Free chlorine (mg/l)	0,5	1,5
Salt (g/l)		8



Failure to keep the swimming pool water between the above mentioned limits will void the warranty.



When the concentration of one or more products mentioned above becomes too high, irrevocable damage to your heat pump may occur. Make sure that you always install water treatment equipment after the heat pump. When an automatic chemical feeder is installed in the plumbing, it must be installed downstream of the heat pump.

9. Winterizing

Although our Sun Spring heat pumps are protected against freezing, it is good practice to drain the complete installation. Perform the following actions to completely drain the heat pump:

- Turn off the electrical power to the heat pump at the main breaker panel.
- Shut off the water supply to the heat pump.
- Disconnect the water inlet and outlet and let the water drain from the heat pump.
- Re-connect the water inlet and outlet loosely to prevent debris entering the connections.



Failure to winterize could cause damage to the heat pump and will void warranty.

9.1 Spring startup

If your heat pump has been winterized, perform the following steps when starting the system in the spring:

- Inspect the system for any debris or structural problems.
- Connect the water inlet and outlet unions firmly.
- Turn on the filter pump to supply water to the heat pump.
- Restore electrical power to the heat pump and switch it ON.

10. Environment

This heat pump should not be put into the domestic waste at the end of its useful life, but must be disposed at a central point for recycling of electrical and electronic domestic applications. By doing this you will help to preserve the environment.



11. Service

If you need service or information or if you have a problem, please contact your local dealer. If needed they will contact the manufacturer to solve your problem.

They are gladly willing to assist you!

You can find more information at www.duratech.be

12. Warranty

LIMITED WARRANTY

We warrant all parts to be free from manufacturing defects in materials and workmanship for a period of TWO years from the date of retail purchase.

This warranty is limited to the first retail purchaser, is not transferable, and does not apply to products that have been moved from their original installation sites. The liability of the manufacturer shall not exceed the repair or replacement of defective parts and does not include any costs for labour to remove and reinstall the defective part, transportation to or from the factory, and any other materials required to make the repair. This warranty does not cover failures or malfunctions resulting from the following:

1. Failure to properly install, operate or maintain the product in accordance with our published "Installation & Instruction Manual" provided with the product.
2. The workmanship of any installer of the product.
3. Not maintaining a proper chemical balance in your pool [pH level between 7,0 and 7,8. Total Alkalinity (TA) between 80 to 150 ppm. Free Chlorine between 0,5 – 1,2mg/l. Total Dissolved Solids (TDS) less than 1200 ppm. Salt maximum 8g/l]
4. Abuse, alteration, accident, fire, flood, lightning, rodents, insects, negligence or acts of Gods.
5. Scaling, freezing or other conditions causing inadequate water circulation.
6. Operating the product at water flow rates outside the published minimum and maximum specifications.
7. Use of non-factory authorized parts or accessories in conjunction with the product.
8. Chemical contamination of combustion air or improper use of sanitizing chemicals, such as introducing sanitizing chemicals upstream of the heater and cleaner hose or through the skimmer.
9. Overheating, incorrect wire runs, improper electrical supply, collateral damage caused by failure of O-rings, DE grids or cartridge elements, or damage caused by running the pump with insufficient quantities of water.

LIMITATION OF LIABILITY

This is the only warranty given by Manufacturer. No one is authorized to make any other warranties on our behalf.

THIS WARRANTY IS IN LIEU OF ALL OTHER WARRANTIES, EXPRESSED OR IMPLIED, INCLUDING BUT NOT LIMITED TO ANY IMPLIED WARRANTY OF FITNESS FOR A PARTICULAR PURPOSE AND MERCHANTABILITY. WE EXPRESSLY DISCLAIM AND EXCLUDE ANY LIABILITY FOR CONSEQUENTIAL, INCIDENTAL, INDIRECT OR PUNITIVE DAMAGES FOR BREACH OF ANY EXPRESSED OR IMPLIED WARRANTY.

This warranty gives you specific legal rights, which may vary, by country.

WARRANTY CLAIMS

For prompt warranty consideration, contact your dealer and provide the following information: proof of purchase, model number, serial number and date of installation. The installer will contact the factory for instructions regarding the claim and to determine the location of the nearest service center.

All returned parts must have a Return Material Authorization number to be evaluated under the terms of this warranty.

