

MR. Titan

INVERTER POOL HEAT PUMP



Table of contents

A. Foreword	1
B. Safety Precautions	2
1. Warning	2
2. Attention	2
3. Safety	4
C. About your heat pump	5
1. Transportation	5
2. Accessories	5
3. Features	5
4. Operating range	6
5. Introduction of different modes	6
6. Technical parameter	6
7. Dimension	8
D. Installation guidance	9
1. Installation reminder	9
2. Wiring	10
3. Electric wiring diagram	10
4. References for protecting devices and cable specification	11
E. Operation guidance	12
1. Key Function	12
2. Screen display	13
3. Operation Instruction	13
F. Testing	16
1. Inspect heat pump before use	16
2. Leakage detection notice and method	16
3. Trial	16
G. Maintenance	17
H. Trouble shooting for common faults	19
I. Water pump control connection	21
J. Wi-Fi operation	Error! Bookmark not defined.

A. Foreword

Thank you for choosing our inverter pool heat pump, which is designed for more silent and energy saving user experience. It is an ideal way for green pool heating.

We hope you'll enjoy using our heat pumps.

Thank you!



Warning, flammable material



Read operator's manual



Operator's manual, operating instructions



Service indicator, read technical manual

B. Safety Precautions

We have provided important safety messages in this manual and on your heat pump.
Please always read and obey all safety messages.

Environment friendly R32 Refrigerant is used for this heat pump

1. Warning



A2L

The WARNING sign denotes a hazard. It calls attention to a procedure, practice, or the like, which, if not correctly performed or adhered to, could result in personal injury or injury to a third party. These signs are rare, but are extremely important.

	a. Keep the heat pump away from fire source.
	b. It must be placed in well ventilated area, indoor or closed area is not allowed.
	c. Repair and disposal must be carried out by trained service personnel
	d. Vacuumize completely before welding. Welding can only be carried out by professional personnel in service center.

2. Attention

- a. Please read the following instructions before installation, use and maintenance.
- b. Installation must be done by professional staff only in accordance with this manual.
- c. Leakage test must be performed after installation.
- d. Please don't stack substances, which will block air flow near inlet or outlet area, otherwise the efficiency of the heat pump will be reduced or even stopped.
- e. Set proper temperature in order to get comfortable water temperature to avoid overheating or overcooling.
- f. In order to optimize the heating effect, please install heat preservation insulation on pipes between swimming pool and the heat pump, and please use a recommended cover on the swimming pool.
- g. Connecting pipes of the swimming pool and the heat pump should be $\leq 10\text{m}$.
- h. Except for the methods recommended by the manufacturer, do not use any methods to accelerate the defrosting process or clean the frosted parts.
- i. If a repair is required, please contact the nearest after-sales service center. The repair process must be strictly in accordance with manual. All repair practice by non-professional is prohibited.
- j. Don't use or stock combustible gas or liquid such as thinners, paint and fuel to avoid fire.
- k. This unit can only be installed outdoors.
- l. This unit can only be connected to a power source with a single complete cord.
- m. This unit contains fluorinated greenhouse gas.

3. Safety

- a. Please keep the main power supply switch far away from the children.
- b. When a power cut happens during operating, and later the power is restored, the heat pump will start up.
- c. Please switch off the main power supply in lightning and storm weather to prevent from machine damage that caused by lightning.
- d. Safety inspection must be carried before the maintenance or repair for heat pumps with R32 gas in order to minimize the risk.
- e. Installation and any repairing should be conducted in the area with good ventilation. The ignition source is prohibited during the operation.
- f. If R32 gas leaks during the installation process, all operations must be stopped immediately and call the service center.

C. About your heat pump

1. Transportation

- a. Always keep upright

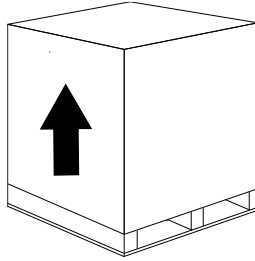

- b. Do not lift the water union
(Otherwise the titanium heat exchanger may be damaged)

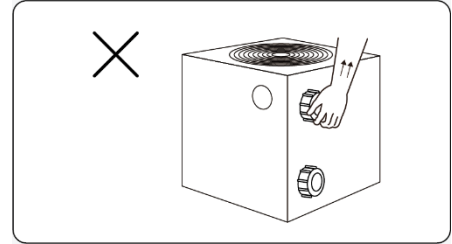

2. Accessories

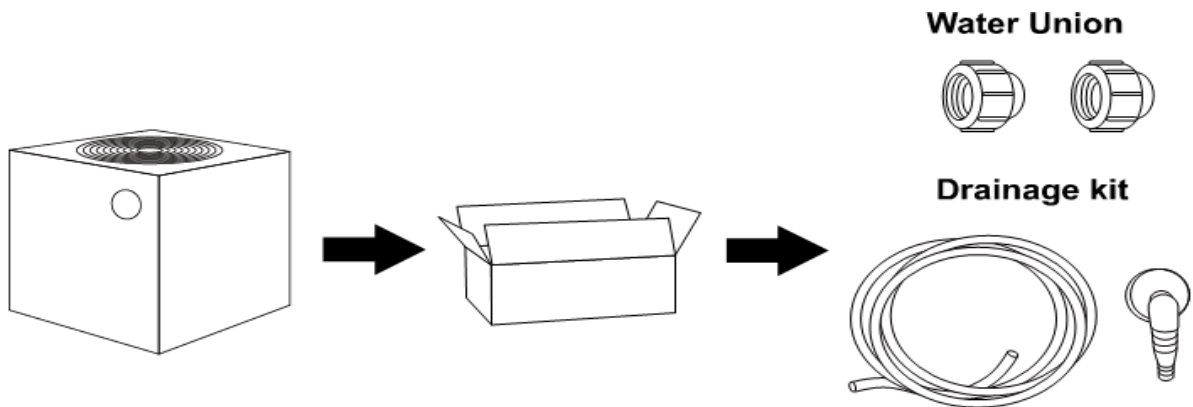

3. Features



- a. DC Twin-rotary inverter compressor
- b. DC Brushless fan motor
- c. EEV Technology
- d. Reverse cycle defrosting with 4-way valve
- e. High-efficiency twisted titanium heat exchanger
- f. Sensitive and accurate temp control and water temp display
- g. High pressure and low pressure protection
- h. Full protection on electrical system

4. Operating range

To provide you comfort and pleasure, please set swimming pool water temperature efficiently and economically. The heat pump can work between air $-10^{\circ}\text{C}\sim 43^{\circ}\text{C}$, and its ideal operation range is between air $15^{\circ}\text{C}\sim 25^{\circ}\text{C}$.

5. Introduction of different modes

- a. The heat pump has two modes: Boost and Silence.
- b. They have different strengths under different conditions.

Mode	Modes	Strength
	Boost mode	Heating capacity: 20% to 100% capacity Intelligent optimization Fast heating
	Silence mode	Heating capacity: 20% to 80% capacity Sound level: 3dB (A) lower than Boost mode

6. Technical parameter

Model	MTC130	MTC210	MTC260
PERFORMANCE CONDITION: Air 27°C/ Water 27°C/ Humid. 80%			
Heating capacity (kW)	13.5	21	26
Heating capacity (kW) in Silence mode	11.3	18.7	23.8
COP range	15~6.9	15.9~7.0	15.0~6.9
Average COP at 50% speed	11.5	11.8	11.5
PERFORMANCE CONDITION: Air 15°C/ Water 26°C/ Humid. 70%			
Heating capacity (kW)	10	15.1	18.6
Heating capacity (kW) in Silence mode	8.6	13.2	17.2
COP range	7.1~5.0	7.8~5.0	7.5~4.8
Average COP at 50% speed	6.9	7.3	7.1
TECHNICAL SPECIFICATIONS			
Advised pool volume (m ³) *	35~65	50~90	60~120
Operating air temperature (°C)	-10°C~43°C		
Power supply	230V~/1Ph/50Hz		
Rated input power (kW)	0.32~2.00	0.45~3.00	0.84~3.91
Rated input current (A)	1.39~8.70	1.96~13.00	3.65~17.00
Sound level at 10m dB(A)	21.0~32.0	32.8~34.7	31.5~35.2
Advised water flux (m ³ /h)	4~6	8~10	10~12
Water connection (mm)	50		
R32 gas weight (g)	750.0	1200.0	2000.0
GWP	675		
CO2 Equivalent (Tonnes)	0.51	0.81	1.35

Remarks:

This heat pump is able to perform normally within air temp -10°C~+43°C, efficiency will not be guaranteed out of this range. Please take into consideration that the pool heat pump performance and parameters are different under various conditions.

Related parameters are subject to adjustment periodically for technical improvement without further notice. For details, please refer to nameplate.

7. Dimension

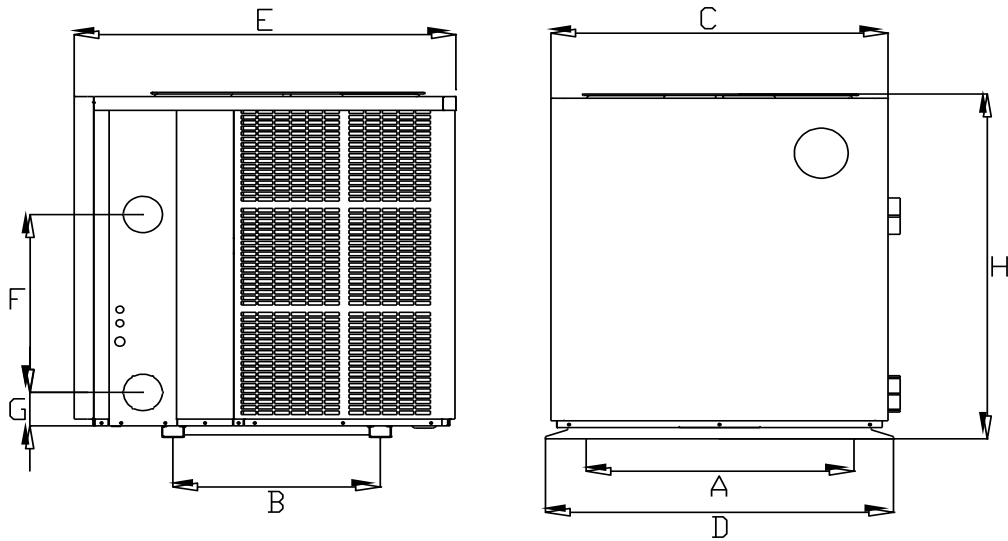

Size(mm) Name	A	B	C	D	E	F	G	H
Model								
MTC130	685	423	689	710	780	320	74	656
MTC210	685	423	689	710	780	390	72	656
MTC260	685	423	689	710	780	460	72	756

※ Above data is subject to modification without notice.

Note: The picture above is the specification diagram of the pool heat pump, for technician's installation and layout reference only. The product is subject to adjustment periodically for improvement without further notice.

D. Installation guidance

1. Installation reminder

Only a professional staff is allowed to install the heat pump. The users are not qualified to install by themselves, otherwise the heat pump might be damaged and risky for users' safety.

a. Location and water pipe connection

 The inverter pool heat pump should be installed in a good ventilation place.

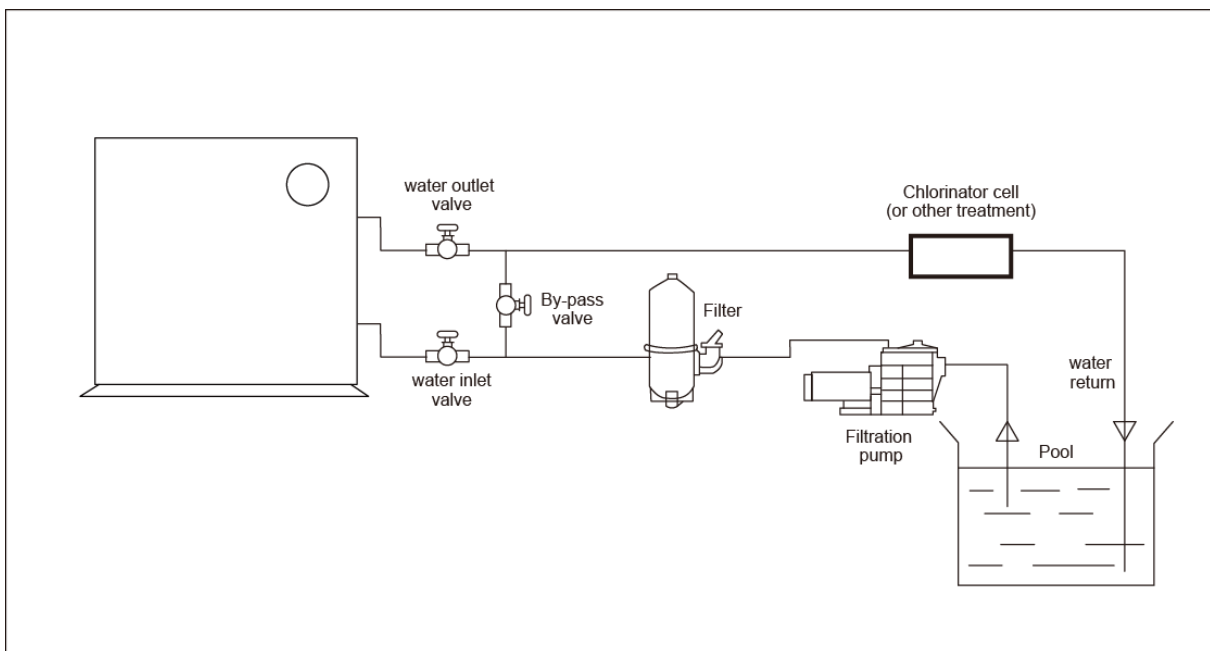
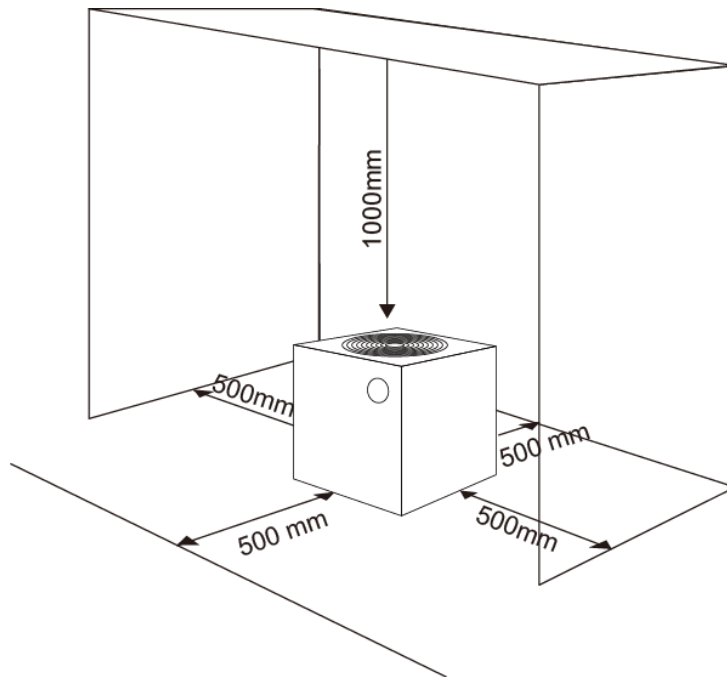

- 1) The frame must be fixed by bolts (M10) to concrete foundation or brackets. The concrete foundation must be solid and fastened; the bracket must be strong enough and antirust treated;
 - 2) Please don't stack substances that will block air flow near inlet or outlet area, and there is no barrier within 50cm behind the main machine, or the efficiency of the heat pump will be reduced or even stopped;
 - 3) The machine needs an appended pump (Supplied by the user). The recommended pump specification-flux: refer to Technical Parameter, Max. lift $\geq 10\text{m}$;
 - 4) When the machine is running, there will be condensation water discharged from the bottom, please pay attention to it. Please hold the drainage nozzle (accessory) into the hole and clip it well, and then connect a pipe to drain the condensation water out.
- b. The inlet and outlet water unions can't stand the weight of soft pipes. The heat pump must be connected with hard pipes!

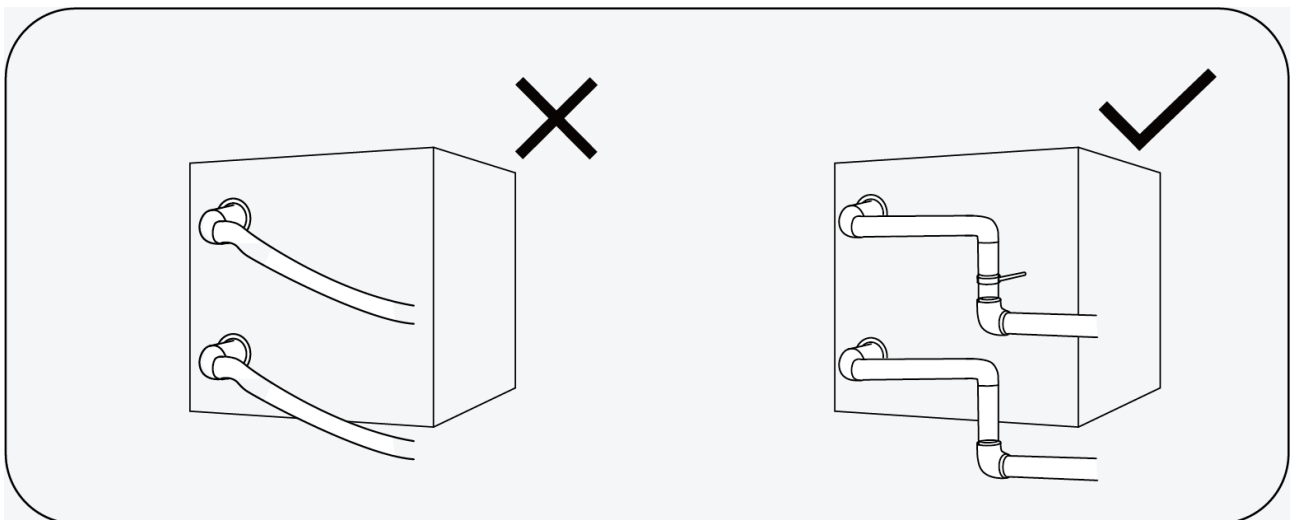

2. Wiring

- a. Connect to appropriate power supply, the voltage should comply with the rated voltage of the products.
- b. Earth the machine well.
- c. Wiring must be handled by a professional technician according to the circuit diagram.
- d. Set leakage protector according to the local code for wiring (leakage operating current $\leq 30\text{mA}$).
- e. The layout of power cable and signal cable should be orderly and not affecting each other.

3. Electric wiring diagram

For power supply: 230V 50Hz

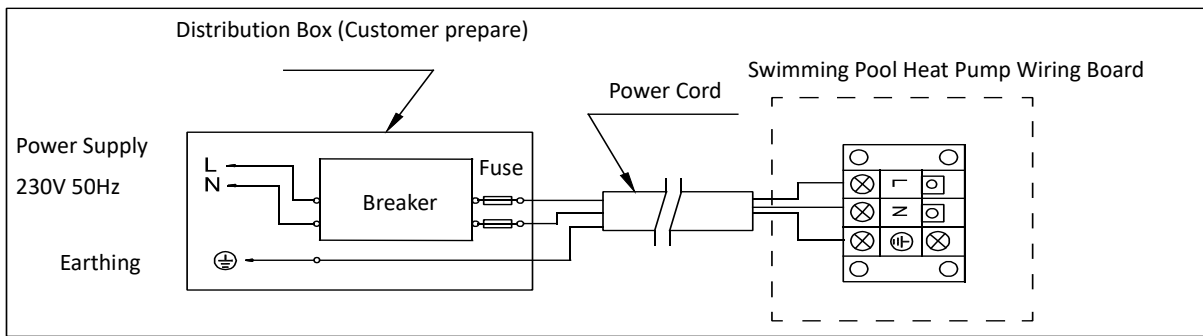

Note:

- 1)  Must be hard wired, plug is not allowed.
- 2) The swimming pool heat pump must be earthed well.

4. References for protecting devices and cable specification

MODEL		MTC130	MTC210	MTC260
Breaker	Rated Current (A)	14	21	24
	Rated Residual Action Current (mA)	30	30	30
Fuse (A)		14	21	24
Power Cord (mm ²)		3×2.5	3×4	3×4









※ Above data is subject to modification without notice.

Note: The above data is adapted to power cord $\leq 10\text{m}$. If power cord is $> 10\text{m}$, wire diameter must be increased.

E. Operation guidance

1. Key Function









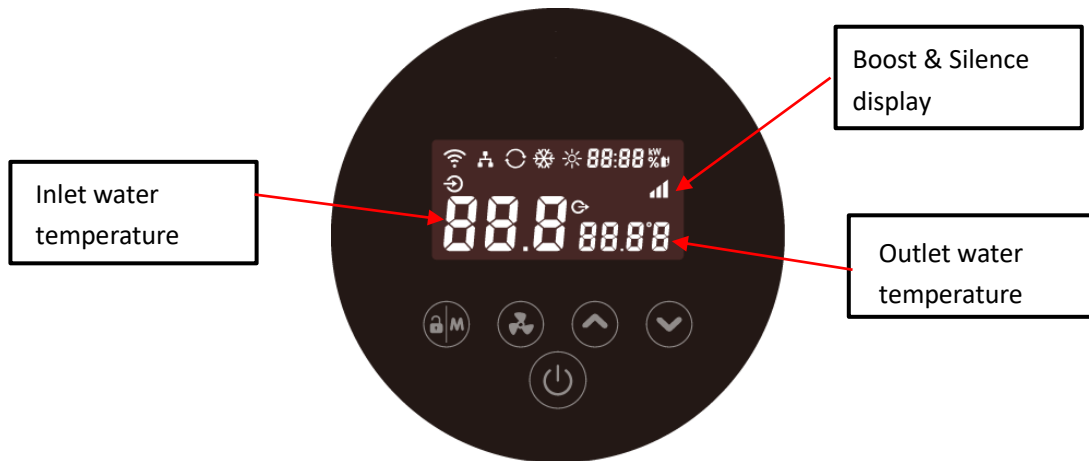

Symbol	Heating only models	Heating & cooling models
	<ol style="list-style-type: none"> 1. Power On/Off 2. Wi-Fi setting 	<ol style="list-style-type: none"> 1. Power On/Off 2. Wi-Fi setting
	Lock/Unlock screen	<ol style="list-style-type: none"> 1. Lock/Unlock Screen 2. Heating mode (18-40°C) 3. Cooling mode (12-30°C) 4. Auto mode (12-40°C)
	<ol style="list-style-type: none"> 1. Boost  2. Silence  	<ol style="list-style-type: none"> 1. Boost  2. Silence 
	Temperature Setting	Temperature Setting

Attention:

- The controller has power-down memory function.
- The buttons will turn dark when it's locked.

2. Screen display





	Heating mode
	Cooling mode
	Auto mode
	Running speed percentage
	Wi-Fi connection
	Inlet
	Outlet

3. Operation Instruction



a. Screen Lock

- 1) Press “” for 3 seconds to lock or unlock the screen
- 2) Automatic Lock Period: 30 seconds if no operation

b. Power On





Press “” for 3 seconds to unlock screen. Press “” to power on machine.

c. Temperature Setting

Press “” and “” to display and set temperature.

d. Mode Selection

1) Heating/Cooling/Auto

Press “” to switch among heating “”, cooling “” and auto mode “”.

Heating mode “”: Water temperature setting range(18-40°C)



Cooling mode “”: Water temperature setting range(12~30°C)

Auto mode “”: Water temperature setting range(12~40°C)

* When water inlet temperature is higher than setting point, automatic cooling mode starts.



* When water inlet temperature is lower than setting point, automatic heating mode starts.

2) Silence/Boost mode selection

Press “” to switch between boost mode , silence mode 

Please choose boost mode  for initial heating





e. Wi-Fi “”

When the screen is on, press “” for 3 seconds, after “” flashing, enter Wi-Fi connection.

Connect Wi-Fi on mobile phone and input password, and then control equipment by Wi-Fi. When APP connects Wi-Fi successfully, “” lights on.

f. Defrosting

1) Automatic defrosting: When machine is auto defrosting,  will flash, and return to previous working mode when it finishes.

2) Manual Defrosting: To enter forced defrosting mode, the compressor must be working more than 10 minutes. In heating mode, press “” and “” on touch controller simultaneously for 5 seconds to start forced defrosting, “” is flashing and defrost starts, “” stop flashing and defrosting stops.

(Remarks: the interval between each manual defrosting should be more than 30 minutes.)

g. Round Controller Running Status Checking

1) Press “” for 5 seconds, it will enter running status checking.



2) During this time, the display will show the status symbol “C0” and its corresponding value.

3) Change status through “” and “”, the corresponding value also changes.

- 4) Press “” to quit “Running Status Checking” mode
- 5) Running status checking table:

Symbol	Content	Unit
C0	Inlet water temp	°C
C1	Outlet water temp	°C
C2	Ambient temp	°C
C3	Exhaust gas temp	°C
C4	Evaporator coil pipe temp	°C
C5	Return gas temp	°C
C6	Cooling coil pipe temp	°C
C9	Cooling plate temp	°C
C10	EEV opening angle	P
C11	DC fan speed	r/min

- 6) Temperature display conversion (Celsius/Fahrenheit)

When the screen is on, Press “” and “” simultaneously for 5 seconds to switch the display between degrees Celsius and degrees Fahrenheit.

F. Testing

1. Inspect heat pump before use

- a. The ventilating device and outlets are operating adequately and are not obstructed.
- b. It's prohibited to install refrigeration pipe or components in corrosive environment.
- c. Inspect the electric wiring on basis of the electric wiring diagram and earthing connection.
- d. Double confirm the main machine power switch should be off.
- e. Inspect the air inlet and outlet.

2. Leakage detection notice and method



- a. Leakage checking is prohibited in closed area.
- b. The ignition source is prohibited during the leakage inspection. A halide torch (or any other detector using a naked flame) shall not be used.
- c. Leakage detection fluids can be applied with most refrigerants but the use of detergents containing chlorine shall be avoided as the chlorine may react with the refrigerant and corrode the copper pipe.
- d. Vacuumize completely before welding. Welding can only be carried out by professional personnel in service center.
- e. Please stop using while gas leakage occur, and contact professional personnel in service center.

3. Trial

- a. The user must "Start the Pump before the Machine, and Turn off the Machine before the Pump", or the machine will be damaged.
- b. Before start the heat pump, please check for any leakage of water.
- c. In order to protect the swimming pool heat pump, the machine is equipped with a time lag starting function, the fan will run 1 minute earlier than the compressor when starting the machine, and it will stop running 1 minute later than the compressor when power off the machine.
- d. After the swimming pool heat pump start up, please kindly checking for any abnormal noise from the machine.

G. Maintenance



“CUT OFF” power supply of the heat pump before cleaning, examination and repairing

1. In winter season when you don't swim:
 - a. Cut off power supply to prevent any machine damage.
 - b. Drain water clear of the machine, when using the machine at ambient temperatures below 2°C, please keeping the water flowing.
 - c. **Before covering the machine with a winter cover, please make sure all water on the surface of the heat pump has been wiped and clean.**
 - d. Cover the machine body when not in use.



!!Important:

Unscrew the water nozzle of inlet pipe to let the water flow out.

When the water in machine freezes in winter season, the titanium heat exchanger may be damaged.

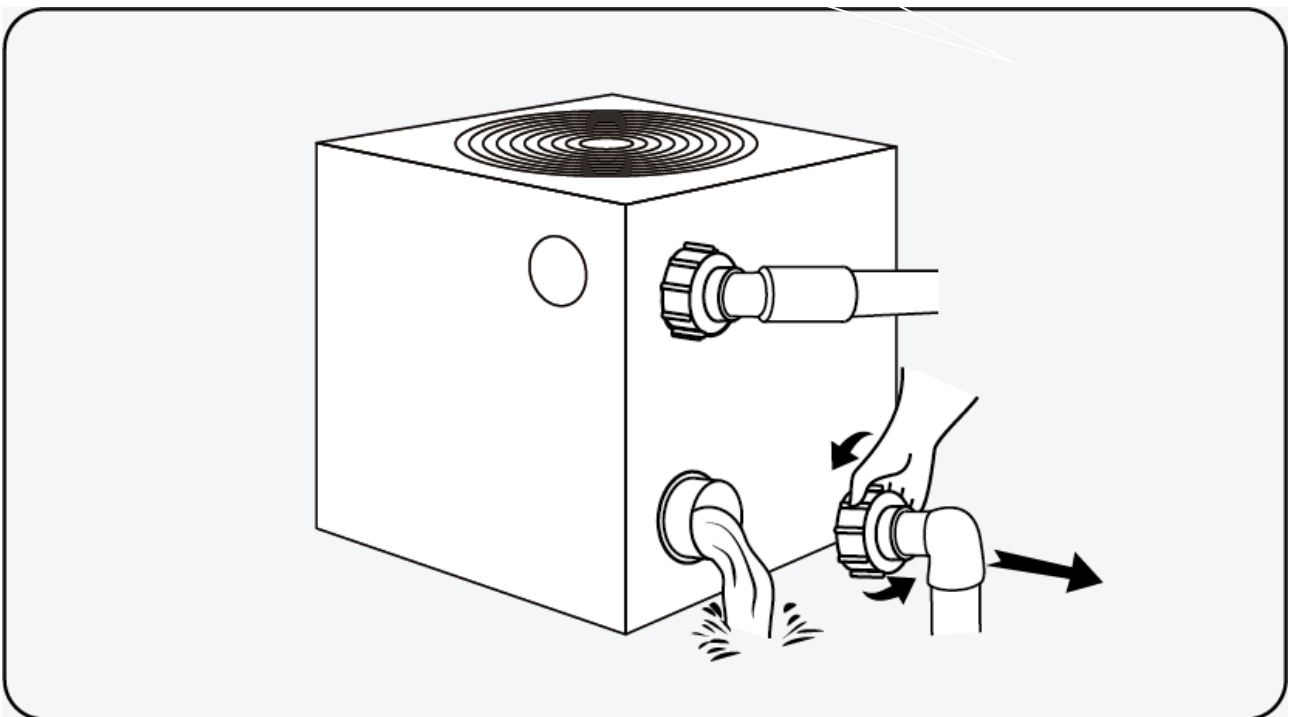

2. Please clean this machine with household detergents or clean water, NEVER use gasoline, thinners or any similar fuel.
3. Check bolts, cables and connections regularly.
4. If repair or scrap is required, please contact authorized service center nearby.
5. Do not attempt to work on the equipment by yourself. Improper operation may cause danger.
6. In case of risking, safety inspection must be carried before the maintenance or repairing for heat pumps with R32 gas.

H. Trouble shooting for common faults

1. Repairing Guidance



WARNING:

- a. If repair or scrap is required, please contact authorized service center nearby.
- b. Requirements for Service Personnel
- c. Any person who is involved with working on or breaking into a refrigerant circuit should hold a current valid certificate from an industry-accredited assessment authority, which authorizes their competence to handle refrigerants safely in accordance with an industry recognized assessment specification.
- d. Do not attempt to work on the equipment by yourself. Improper operation may cause danger.
- e. Strictly comply with the manufacturer's requirements when charging R32 gas and equipment maintenance. This chapter focuses on special maintenance requirements for swimming pool heat pump with R32 gas. Please refer to the technical service manual for detailed maintenance operation.
- f. Vacuumize completely before welding. Welding can only be carried out by professional personnel in service center.

2. Failure solution and code

Failure	Reason	Solution
When powered on, the controller displays a code	Startup code	This is normal. Please wait until it disappears.
Unresponsive controller	Some models have screen lock function.	Refer to the manual to unlock the screen
Heat pump doesn't run	Improper operation	Refer to the manual
	No power	Wait until the power recovers
	Unit is powered off	Switch on the power
	Burned fuse	Check and change the fuse
	The breaker is off	Check and turn on the breaker
	Voltage anomaly	Inspection by professional
Unit suddenly starts or stops running	The unit may be in defrost. At this point the fan stops spinning and the heat indicator on the controller will flash	Not failure, the unit will switch back after defrosting
	Some models have a timed power on/off function.	Refer to the manual to disable this function
	Once the set temperature is reached, the heat pump will go into standby	This is normal
Air is blowing out, but unit is not heating well	Evaporator blocked	Clear the blockage
	Air inlet and/or outlet blocked	Clear the blockage
	3 minutes start delay protection for compressor	Wait patiently
Display normal, but no heating	Set temperature too low	Set to proper temperature
	3 minutes start delay protection for compressor	Wait patiently
Unit is releasing white smoke	The unit is defrosting	This is normal. Please wait until unit finished defrosting.
Unit is leaking water	In heating mode, condensation will be generated on the evaporator and released through the bottom of the unit	This is normal
If above solutions don't work, please contact your installer with detailed information and your model number. Don't try to repair it yourself.		

Note: If the following conditions happen, please stop the machine immediately, and cut off the power supply immediately. Then contact your dealer:

1. Unit has stopped running because of external factors
2. The fuse is frequently broken or leakage circuit breaker jumped.

Protection & Failure code

NO.	Display	Protection code description
-----	---------	-----------------------------

1	E3	No water protection
2	E5	Power supply excesses operation range
3	E6	Excessive temp difference between inlet and outlet water(Insufficient water flow protection)
4	Eb	Ambient temperature too high or too low protection
5	Ed	Anti-freezing reminder
NO.	Display	Failure code description
1	E1	High pressure protection
2	E2	Low pressure protection
3	E4	3 phase sequence protection (three phase only)
4	E7	Water outlet temp too high or too low protection
5	E8	High exhaust temp protection
6	EA	Evaporator overheat protection (only at cooling mode)
7	P0	Controller communication failure
8	P1	Water inlet temp sensor failure
9	P2	Water outlet temp sensor failure
10	P3	Gas exhaust temp sensor failure
11	P4	Evaporator coil pipe temp sensor failure
12	P5	Gas return temp sensor failure
13	P6	Cooling coil pipe temp sensor failure
14	P7	Ambient temp sensor failure
15	P8	Cooling plate sensor failure
16	P9	Current sensor failure
17	PA	Restart memory failure
18	F1	Compressor drive module failure
19	F2	PFC module failure
20	F3	Compressor start failure
21	F4	Compressor running failure
22	F5	Inverter board over current protection
23	F6	Inverter board overheat protection
24	F7	Current protection
25	F8	Cooling plate overheat protection
26	F9	Fan motor failure
27	Fb	Power filter plate No-power protection
28	FA	PFC module over current protection

I. Water pump control connection

Water pump: 230V voltage, $\leq 500\text{W}$ capacity

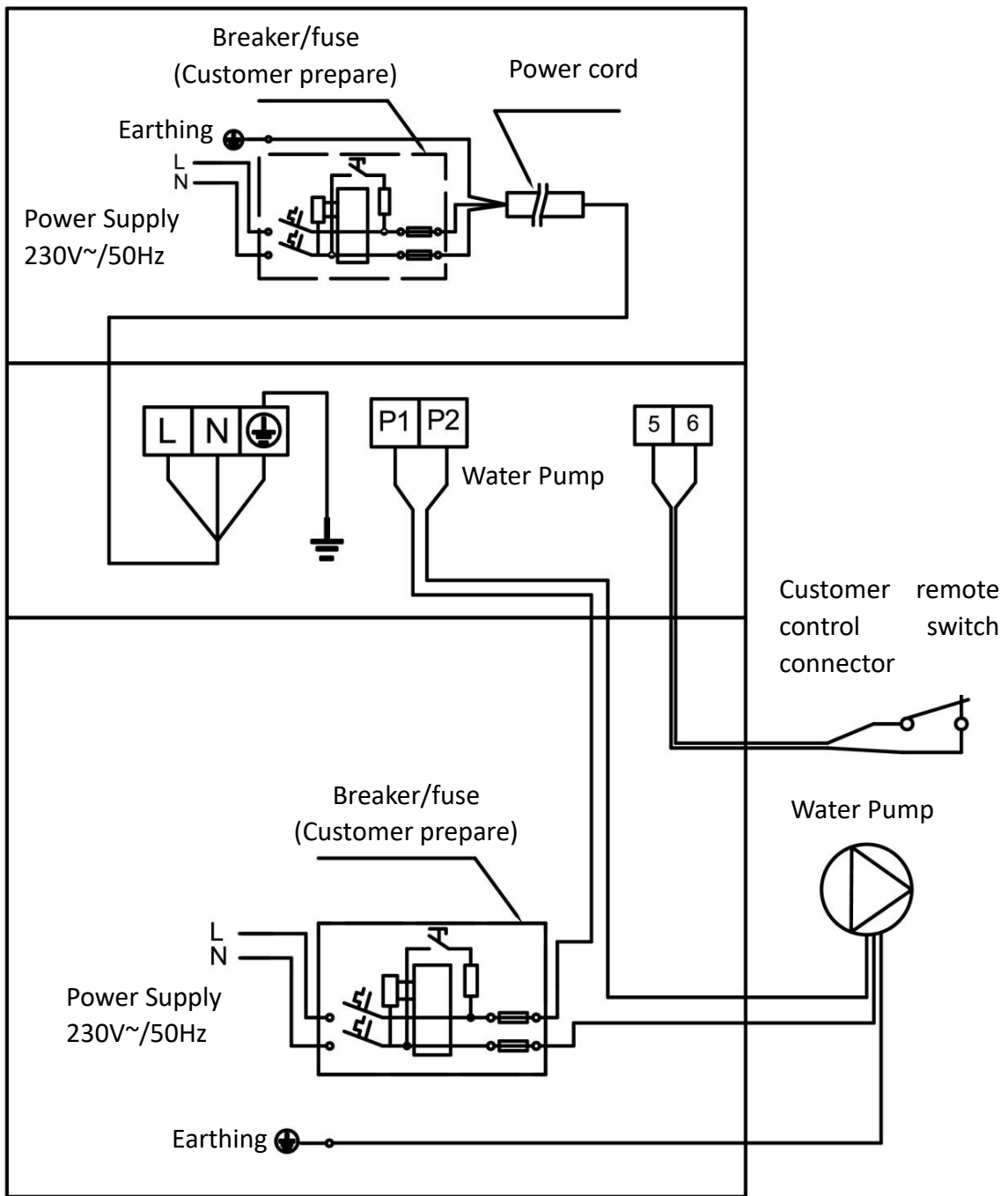

Water pump: 230V voltage, >500W capacity

Please install contactor

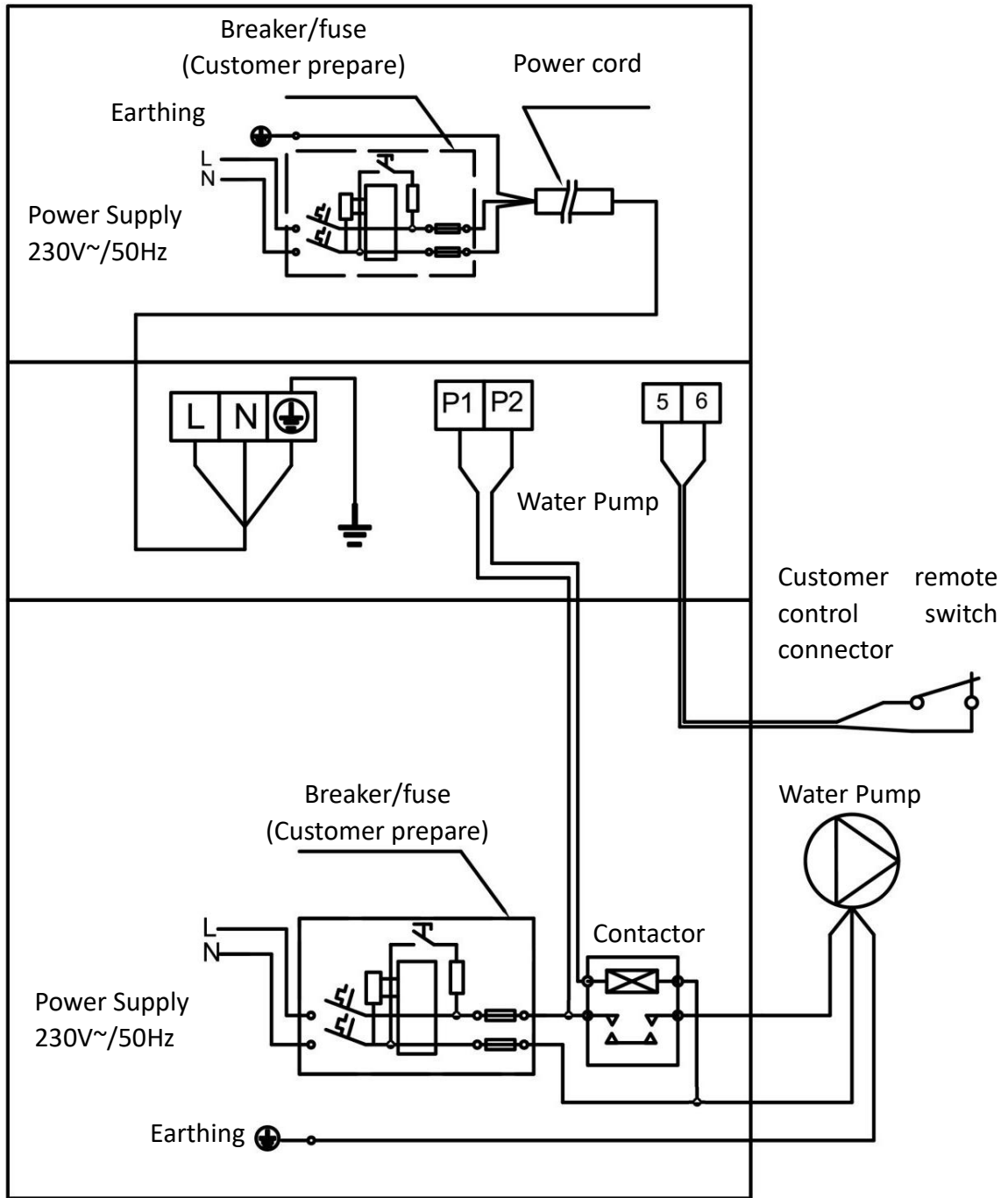

Water pump control and timer connection

1: Water pump timer

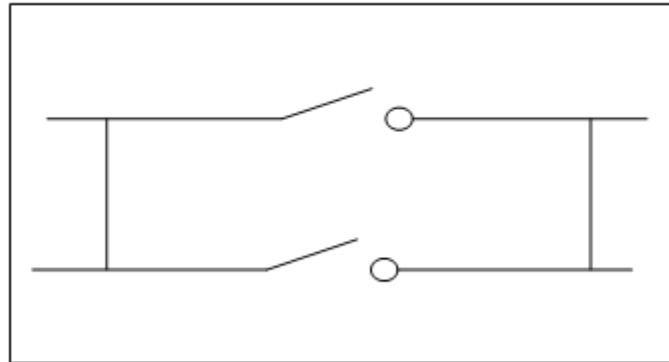

2: Water pump wiring of Heat Pump

Note: The installer should connect 1 parallel with 2 (as above picture). To start the water pump, condition 1 or 2 is connected. To stop the water pump, both 1 and 2 should be disconnected.

1. Download iGarden APP

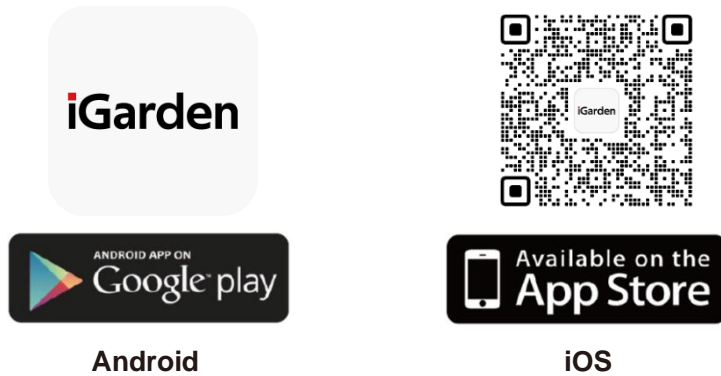

2. Account Registration

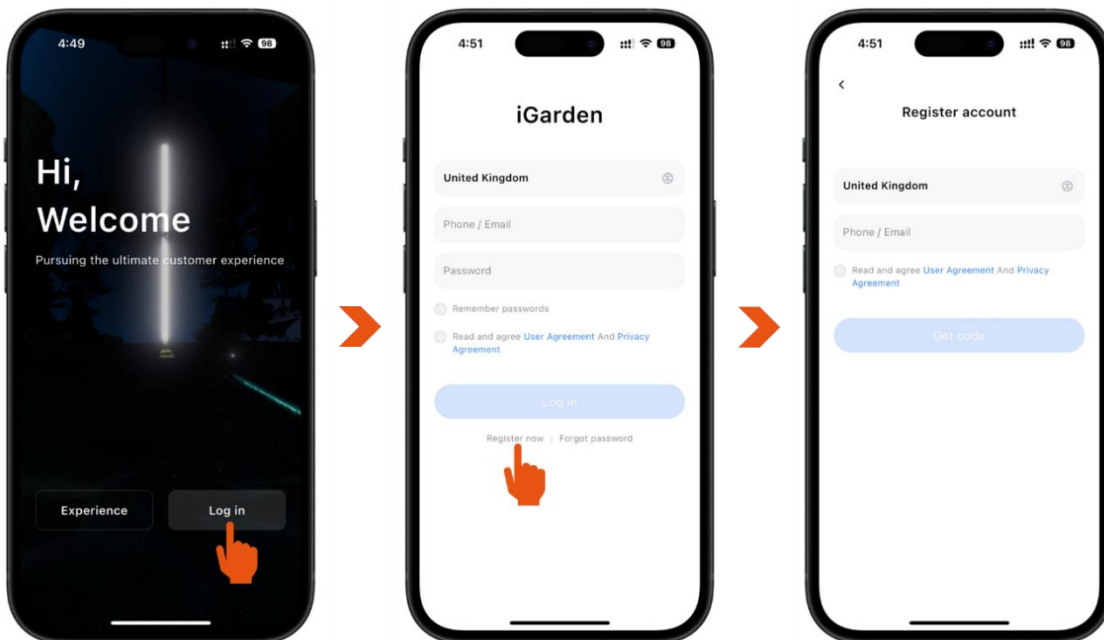



3. APP Paring

a. With Bluetooth

- 7) Please confirm that your phone is connected to Wi-Fi (2.4 GHz) and your Bluetooth is on.
- 8) On the controller of the heat pump, Press "🔌" for 3 seconds to unlock the screen. Press "🔌" for 3 seconds and release. After hearing "Beep", "📶" on controller will flash.



9) Click “Add Device” and then follow the instructions to pair device. During connection, “” on controller will keep flashing. Once the app connects to Wi-Fi successfully, “” will keep displaying.

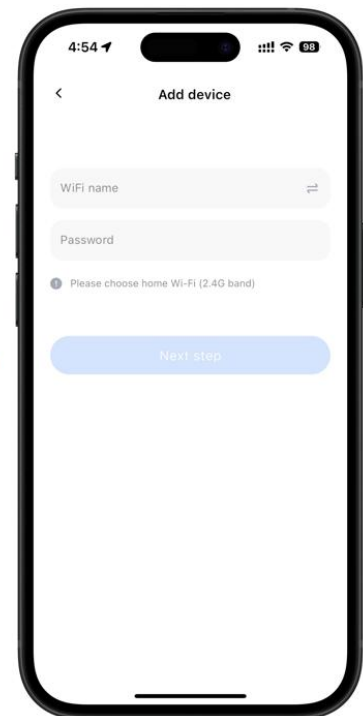
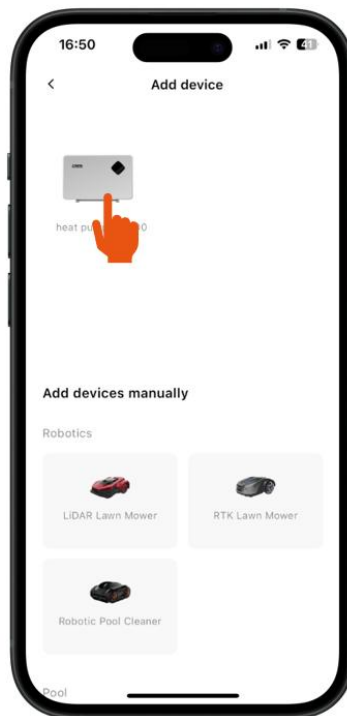
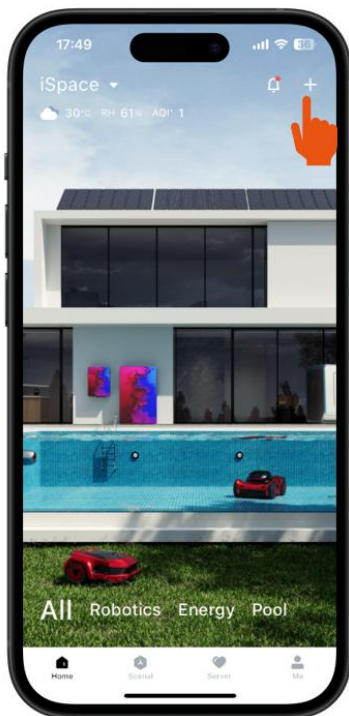

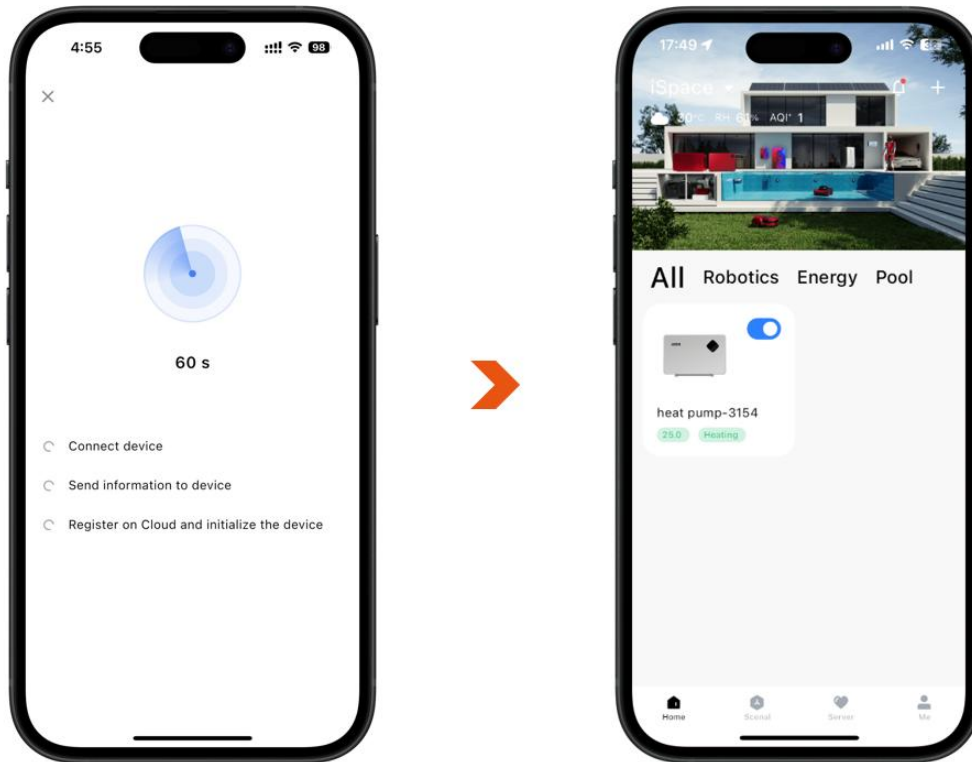

b. With hotspot from heat pump

- 1) Please confirm that your phone is connected to Wi-Fi (2.4 GHz).
- 2) On the controller of the heat pump, Press "📶" for 3 seconds to unlock the screen. Press "🔌" for 10 seconds. After hearing "Beep", "📶" on controller will flash slowly.



- 3) Click "Add Device" and "Heat Pump" under "Add devices manually", then follow the instructions to pair device. Once the app connects to Wi-Fi successfully, "📶" will keep displaying.

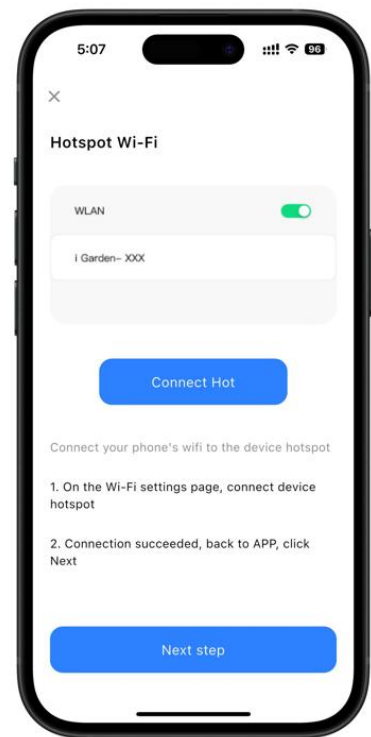
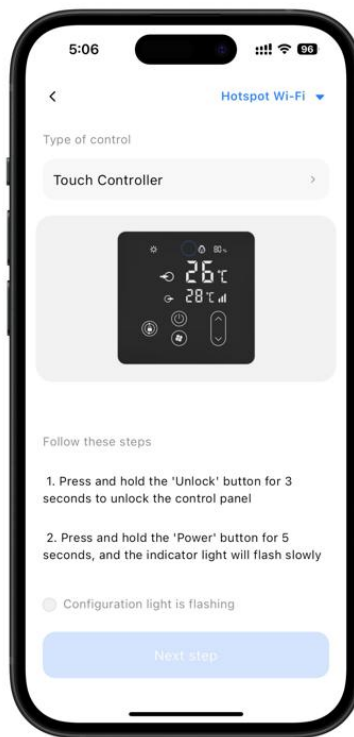
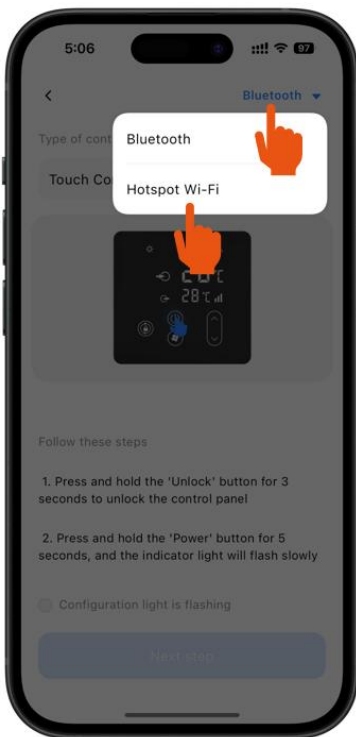
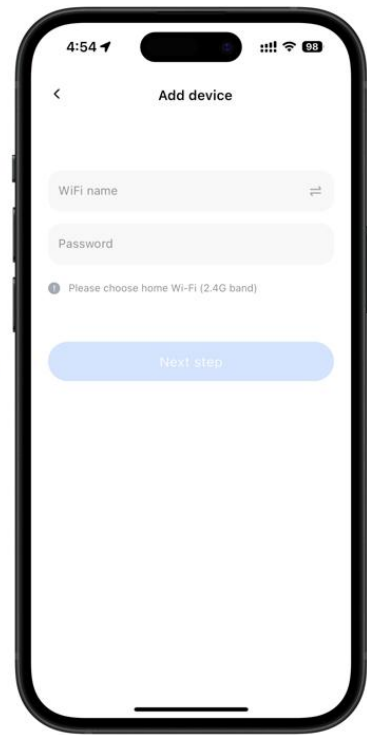
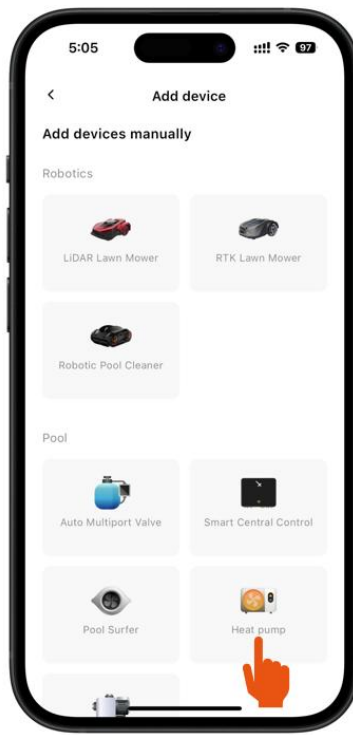

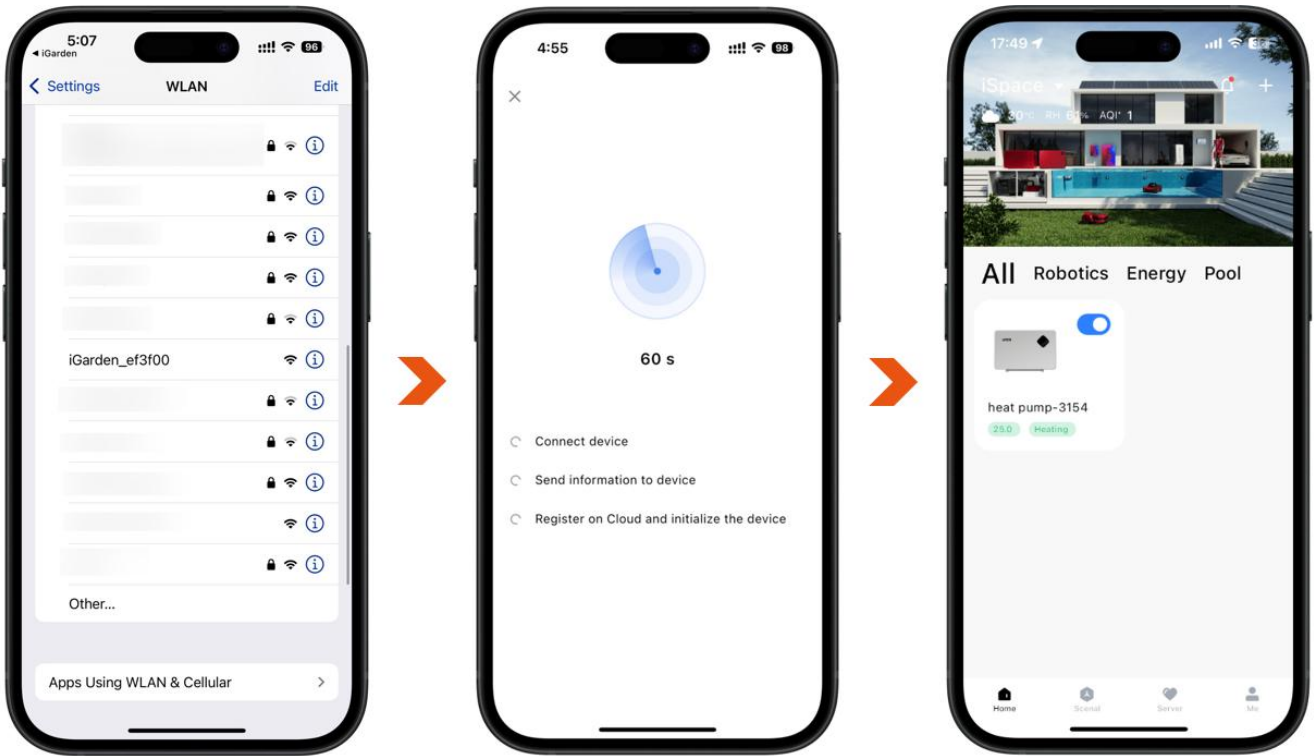

4. Operation

a. For heat pump with Heating & Cooling function

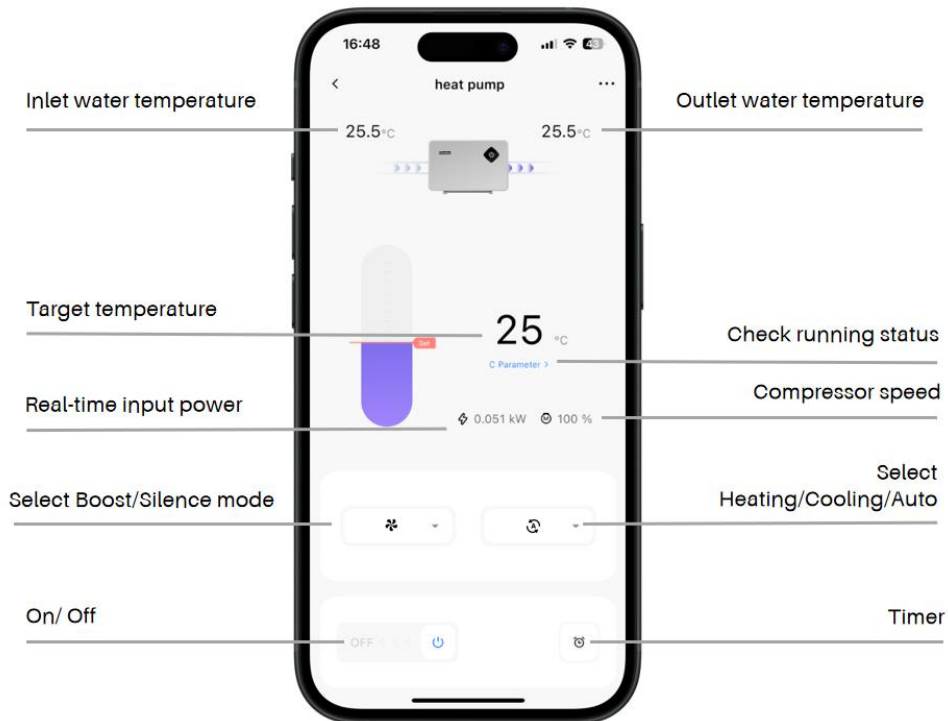

The final interpretation right of the above belongs to the manufacturer

Manufacturer:

Company name: Aquark Technology Limited
Address: Keyuan 2 Road, Ronggui, Shunde, Foshan, P.R. China 528306
Tel: +86 20 37814693

Importer:

Company name: Dantherm Group Ltd
Address: Unit 12 Galliford Road, Maldon, CM9 4XD, United Kingdom
Tel: +44 1621 856 611, email: sales.uk@dantehrmgroup.com

AQ00CV-R32-V26

The company reserves all rights for final explanation.